

IPVA High-pressure Internal Gear Pumps Technical Data Sheet

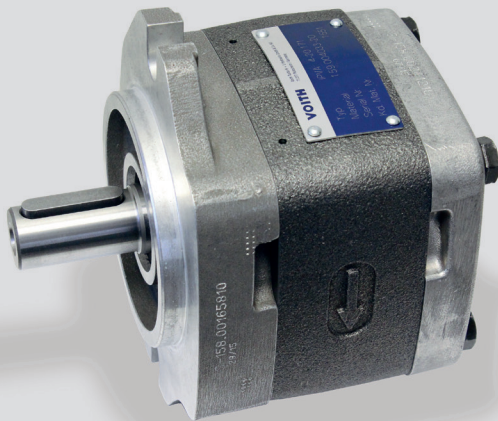

Function

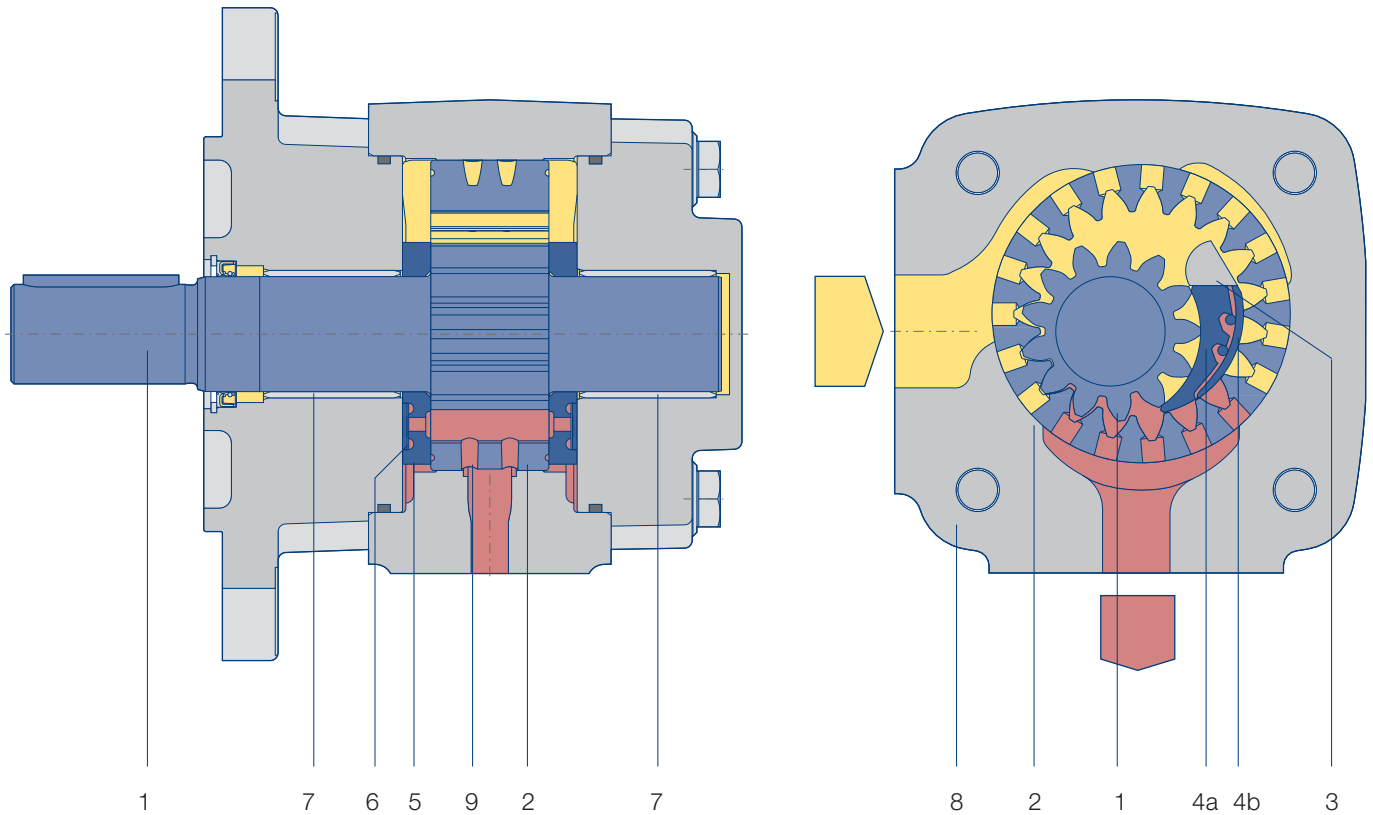

- | | |
|---------------------------|-----------------------|
| 1 Pinion shaft | 5 Axial disc |
| 2 Internal gear | 6 Axial pressure area |
| 3 Filler pin | 7 Plain bearings |
| 4a Filler segment carrier | 8 Housing |
| 4b Filler sealing segment | 9 Hydrostatic bearing |

- | |
|--------------------|
| ■ Suction chamber |
| ■ Pressure chamber |

By rotation of the gears inside the pump, the pressure fluid (usually hydraulic oil) is drawn into the cavity between the pinion and internal gear. Optimized cross-sectional areas on suction side as well as on pressure side allow operation over a wide range of speed.

In the radial direction, the gear chambers are closed by gear meshing and the filler piece. In the axial direction, the axial plates seal the pressure chamber with the minimal possible gap. This design minimizes volume losses and increases efficiency.

Technical Data

Design	Internal gear pump with radial and axial sealing gap compensation
Type	IPVA
Mounting types	SAE hole flange; ISO 3019/1
Line mounting	SAE suction and pressure flange J 518 C Code 61
Sense of rotation	Right hand rotation
Mounting position	any
Shaft load	For details of radial and axial drive shaft loads please contact your Voith Turbo H + L Hydraulic representative
Input pressure	0.8...3 bar absolute pressure
Pressure fluid	HLP mineral oils DIN 51524, part 2 or 3
Viscosity range of the pressure fluid	10...300 mm ² s ⁻¹ (cSt)
Permissible start viscosity	max. 2000 mm ² s ⁻¹ (cSt)
Permissible temperature of the pressure fluid	-20 ... +80 °C
Required purity of the pressure fluid according to NAS 1638	Class 19 / 17 / 14 (ISO 4406), Class 8 (NAS 1638)
Filtration	Filtration quotient min. $\beta_{20} \geq 75$, recommended $\beta_{10} \geq 100$ (longer life)
Permissible ambient temperature	-20 ... +60 °C

Calculations

Pump flow	$Q = V_{g\ th} \cdot n \cdot \eta_v \cdot 10^{-3}$ [l/min]
Power	$P = \frac{Q \cdot \Delta p}{600 \cdot \eta_g}$ [kW]
$V_{g\ th}$	Pump volume per revolution [cm ³]
n	Speed [min ⁻¹]
η_v	Volumetric efficiency
η_g	Overall efficiency
Δp	Differential pressure [bar]

Characteristics

Type, size – delivery	Displace- ment per revolution [cm ³]	Speed		Delivery	Pressures		
		min.	max.	at 1500 min ⁻¹	Continuous pressure	Peak pressure at 1500 min ⁻¹	Moment of inertia
		[min ⁻¹]	[min ⁻¹]	[l/min]	[bar]	[bar]	[kg cm ²]
IPVA 3 – 3.5	3.6	400	3600	5.4	300	320	0.34
IPVA 3 – 5	5.2	400	3600	7.8	300	320	0.42
IPVA 3 – 6.3	6.4	400	3600	9.6	300	320	0.49
IPVA 3 – 8	8.2	400	3600	12.3	300	320	0.58
IPVA 3 – 10	10.2	400	3600	15.3	300	320	0.70
IPVA 4 – 13	13.3	400	3600	19.9	300	320	2.25
IPVA 4 – 16	15.8	400	3400	23.7	300	320	2.64
IPVA 4 – 20	20.7	400	3200	31.0	300	320	3.29
IPVA 4 – 25	25.4	400	3000	38.1	300	320	3.70
IPVA 4 – 32	32.6	400	2800	48.9	250	280	4.44
IPVA 5 – 32	33.1	400	3000	49.6	300	320	8.62
IPVA 5 – 40	41.0	400	2800	61.5	300	320	10.20
IPVA 5 – 50	50.3	400	2500	75.4	280	315	11.60
IPVA 5 – 64	64.9	400	2200	97.3	230	250	14.40
IPVA 6 – 64	64.1	400	2600	96.1	300	320	25.73
IPVA 6 – 80	80.7	400	2400	121.0	280	315	30.90
IPVA 6 – 100	101.3	400	2100	151.9	250	300	36.10
IPVA 6 – 125	126.2	400	1800	189.3	210	250	43.70

The values given apply for:

- Pumping of mineral oils with a viscosity of 20...40 mm²s⁻¹
- An input pressure of 0.8...3.0 bar absolute

Notes:

- Peak pressures apply for 15% of operating time with a maximum cycle time of 1 minute.
- Please inquire about peak pressures at non-standard speeds.
- Due to production tolerances, the pump volume may be reduced by up to 1.5%.

IPVA 3, Rotation and Dimensions

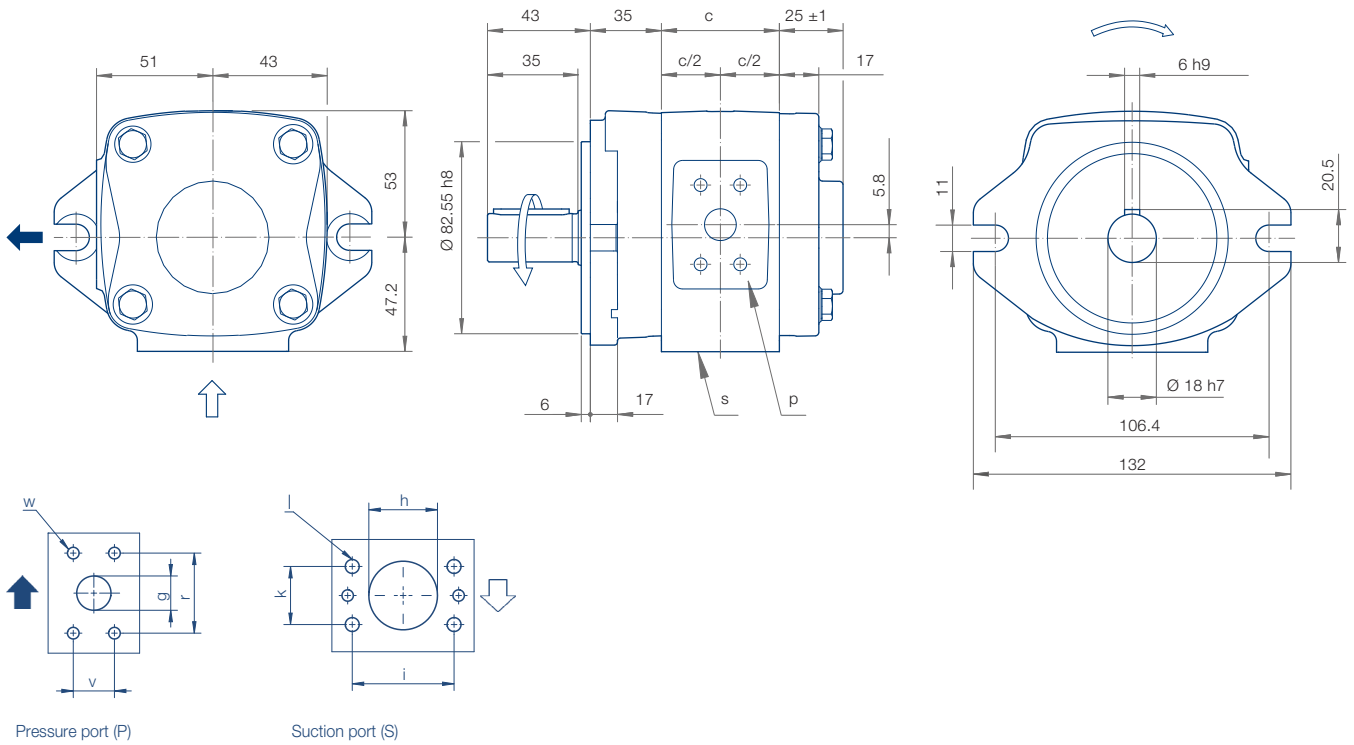

Type/ Delivery	Dimensions and Weight										SAE Flange No.	
	c	g	h	i	k	l	r	v	w	Weight	↑	↓
	[mm]	[mm]	[mm]	[mm]	[mm]	Thread	[mm]	[mm]	Thread	[kg]		
IPVA 3 – 3.5	35	9	14	38.1	17.5	M8x13	38.1	17.5	M8x13	3.4	10	10
IPVA 3 – 5	39	11	14	38.1	17.5	M8x13	38.1	17.5	M8x13	3.6	10	10
IPVA 3 – 6.3	42	11	19	47.6	22.3	M10x15	38.1	17.5	M8x13	3.8	10	11
IPVA 3 – 8	46.5	13	19	47.6	22.3	M10x15	38.1	17.5	M8x13	4.0	10	11
IPVA 3 – 10	51.5	13	21	52.4	26.2	M10x15	38.1	17.5	M8x13	4.2	10	12

IPVA 3, Design

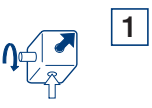
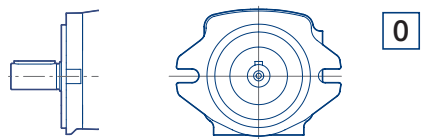
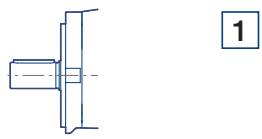
Rotation	Mounting flange	Shaft end
Standard		
Rotation clockwise	SAE 2-hole flange	Parallel shaft with keyway connection
		

IPVA 4, Rotation and Dimensions

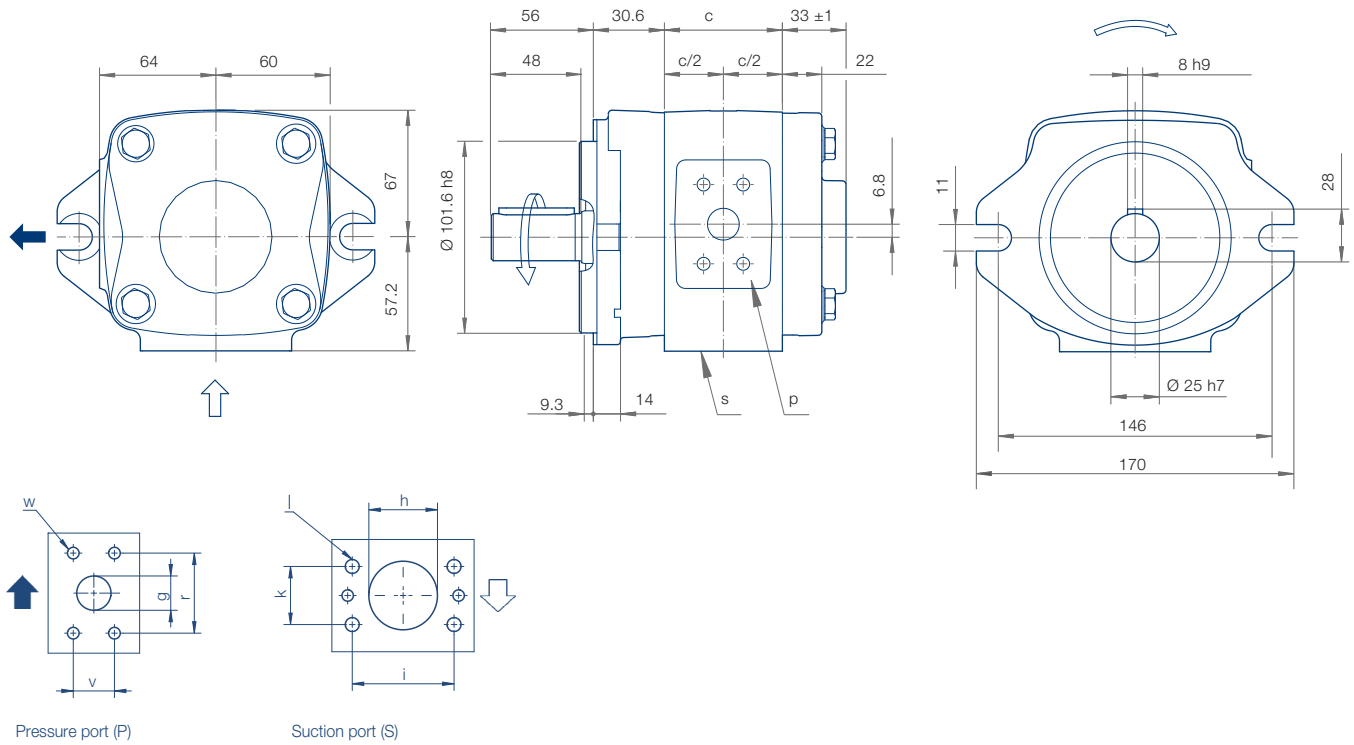

Type/ Delivery	Dimensions and Weight										SAE Flange No.	
	c	g	h	i	k	l	r	v	w	Weight	↑	↓
	[mm]	[mm]	[mm]	[mm]	[mm]	Thread	[mm]	[mm]	Thread	[kg]		
IPVA 4 – 13	48.5	13	23	52.4	26.2	M10x15	38.1	17.5	M8x13	7.1	10	12
IPVA 4 – 16	52.5	14	25	52.4	26.2	M10x15	38.1	17.5	M8x13	7.3	10	12
IPVA 4 – 20	58	18	27	58.7	30.2	M10x15	47.6	22.3	M10x15	7.9	11	13
IPVA 4 – 25	64	18	30	58.7	30.2	M10x15	47.6	22.3	M10x15	8.3	11	13
IPVA 4 – 32	73	18	32	58.7	30.2	M10x15	47.6	22.3	M10x15	9.1	11	13

IPVA 4, Design

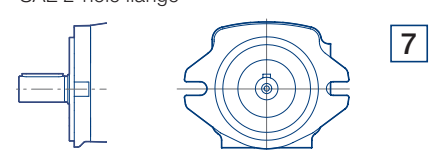
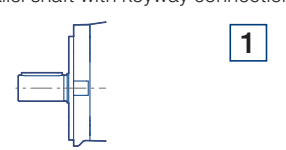
Rotation	Mounting flange	Shaft end
Standard		
Rotation clockwise	SAE 2-hole flange	Parallel shaft with keyway connection
		

IPVA 5, Rotation and Dimensions

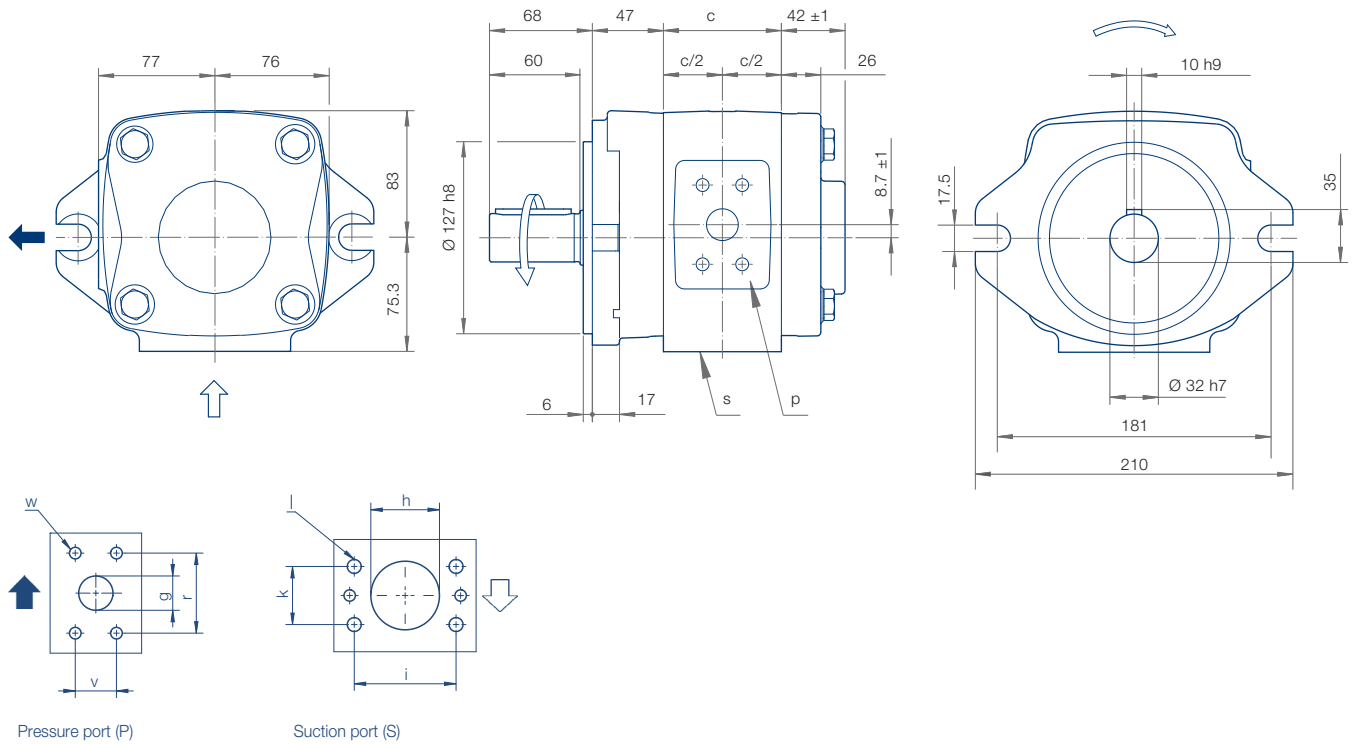

Type/ Delivery	Dimensions and Weight										SAE Flange No.	
	c	g	h	i	k	l	r	v	w	Weight	↑	↓
	[mm]	[mm]	[mm]	[mm]	[mm]	Thread	[mm]	[mm]	Thread	[kg]		
IPVA 5 – 32	65	18	32	58.7	30.2	M10x15	47.6	22.3	M10x15	13.0	11	13
IPVA 5 – 40	71	19	35	69.9	35.7	M12x20	52.4	26.2	M10x15	14.1	12	30
IPVA 5 – 50	78	21	40	69.9	35.7	M12x20	52.4	26.2	M10x15	15.9	12	30
IPVA 5 – 64	89	23	40	69.9	35.7	M12x20	52.4	26.2	M10x16	17.3	12	30

IPVA 5, Design

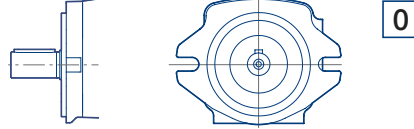
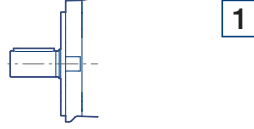
Rotation	Mounting flange	Shaft end
Standard		
Rotation clockwise	SAE 2-hole flange	Parallel shaft with keyway connection
		

IPVA 6, Rotation and Dimensions

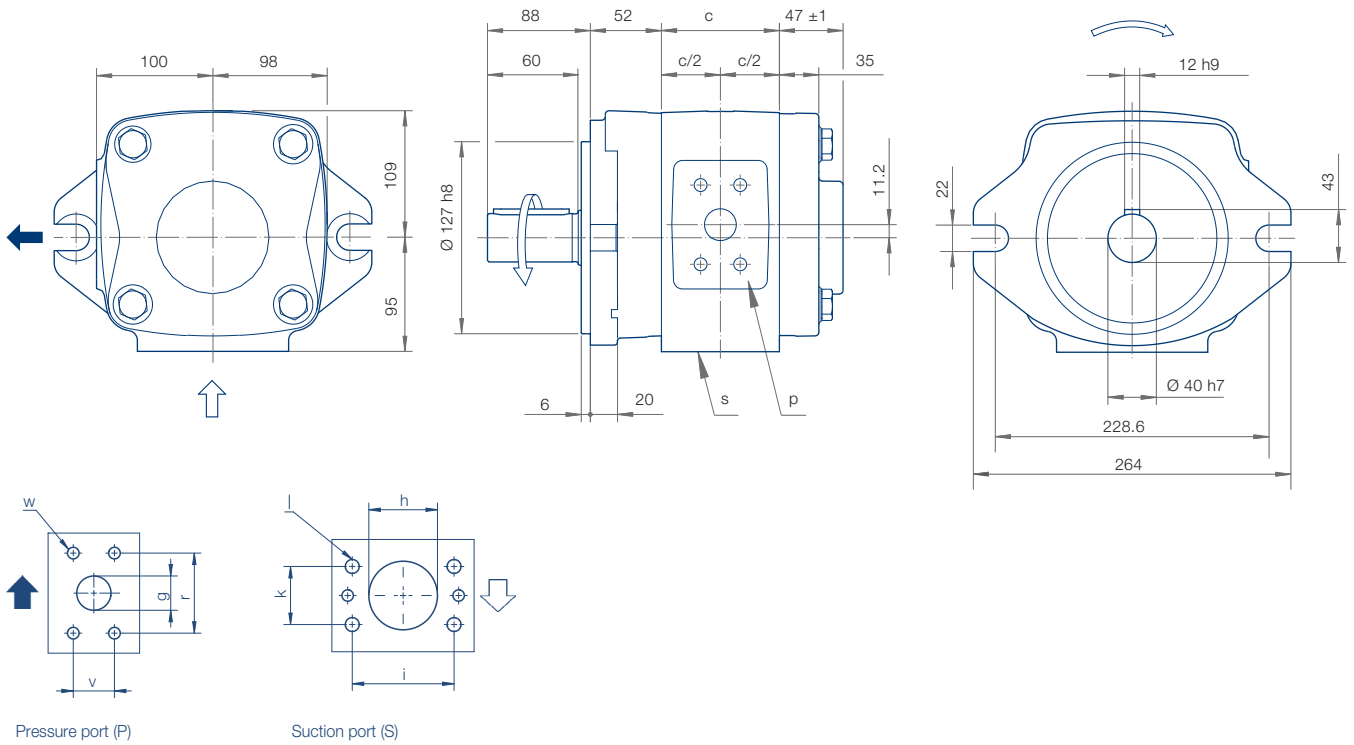

Type/ Delivery	Dimensions and Weight										SAE Flange No.	
	c	g	h	i	k	l	r	v	w	Weight	↑	↓
	[mm]	[mm]	[mm]	[mm]	[mm]	Thread	[mm]	[mm]	Thread	[kg]		
IPVA 6 – 64	80	23	40	69.9	35.7	M12x20	52.4	26.2	M10x15	26.3	12	30
IPVA 6 – 80	88	23	45	77.8	42.9	M12x20	69.9	35.7	M12x20	27.9	14	15
IPVA 6 – 100	98	27	50	77.8	42.9	M12x20	69.9	35.7	M12x20	31.2	14	15
IPVA 6 – 125	110	30	50	77.8	42.9	M12x20	69.9	35.7	M12x20	34.0	14	15

IPVA 6, Design

Rotation

Mounting flange

Shaft end

Standard

Rotation clockwise



SAE 2-hole flange

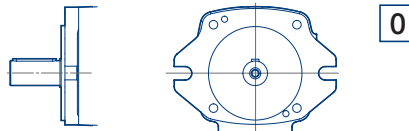

Parallel shaft with keyway connection

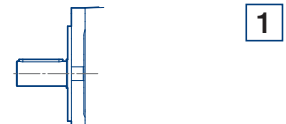

IPVA 3 – Airborne noise level (measuring location 1 m axial)

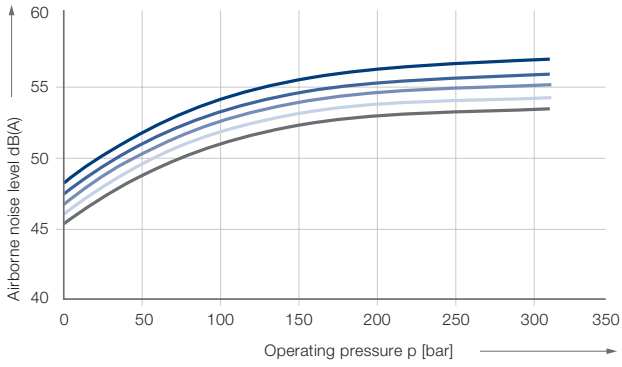

Characteristic curves:

- IPVA 3 – 10
- IPVA 3 – 8
- IPVA 3 – 6.3
- IPVA 3 – 5
- IPVA 3 – 3.5

IPVA 3 – Efficiency η_v and η_g

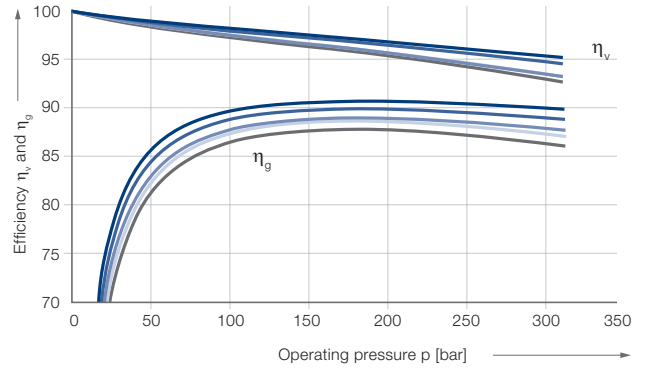

IPVA 4 – Airborne noise level (measuring location 1 m axial)

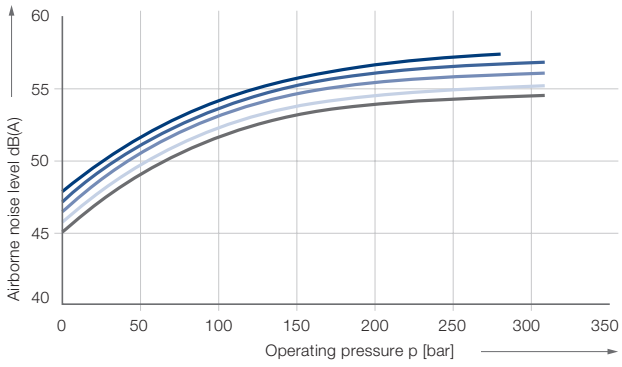

Characteristic curves:

- IPVA 4 – 32
- IPVA 4 – 25
- IPVA 4 – 20
- IPVA 4 – 16
- IPVA 4 – 13

IPVA 4 – Efficiency η_v and η_g

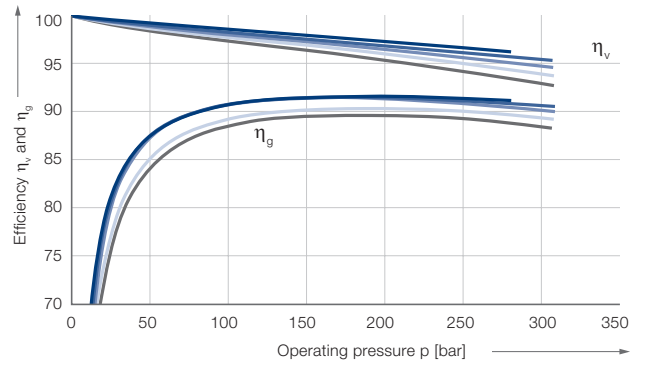

IPVA 5 – Airborne noise level (measuring location 1 m axial)

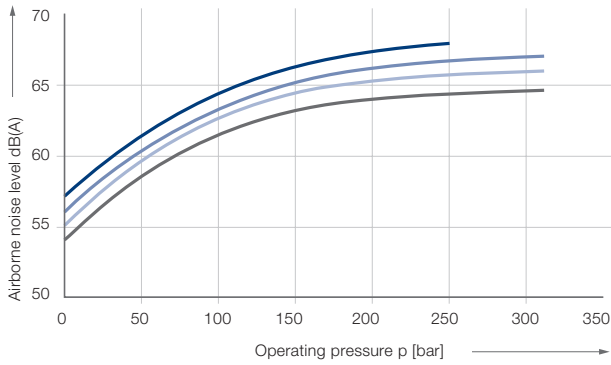

Characteristic curves:

— IPVA 5 – 64 — IPVA 5 – 50 — IPVA 5 – 40 — IPVA 5 – 32

IPVA 5 – Efficiency η_v and η_g

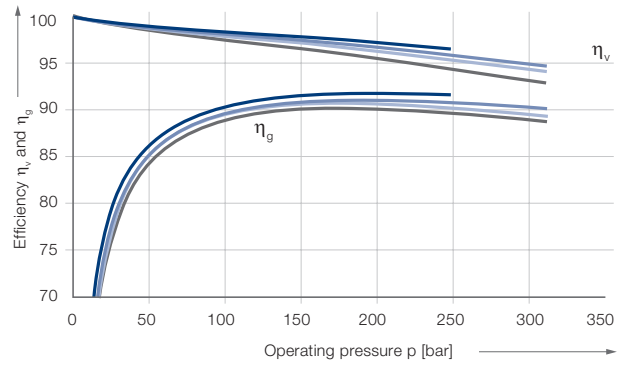

IPVA 6 – Airborne noise level (measuring location 1 m axial)

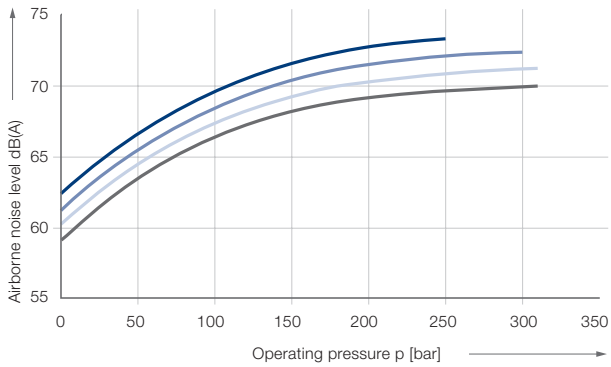

Characteristic curves:

— IPVA 6 – 125 — IPVA 6 – 100 — IPVA 6 – 80 — IPVA 6 – 64

IPVA 6 – Efficiency η_v and η_g

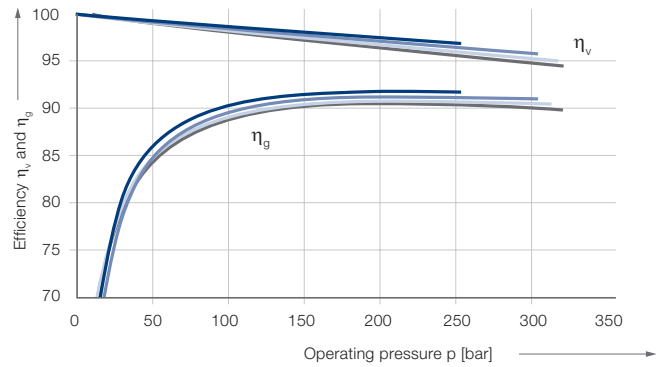

Measurement Conditions:

Speed: 1.500 rpm / Viscosity of pressure fluid: $46 \text{ mm}^2\text{s}^{-1}$ / Operating temperature: $40 \text{ }^\circ\text{C}$

Note:

Measurement taken in a low-noise room. In a anechoic room, the measurements are approx. 5 dB(A) lower.

SAE-Flange, SAE J 518 C Code 61, single-piece

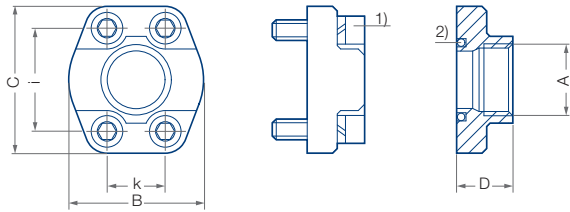

Wrench torque for screws according to ISO 6162

- ¹⁾ Round seal ring (O-Ring) ISO-R 1629 NBR
- ²⁾ Screw EN ISO 4762
- ³⁾ Special design, deviation from SAE J 518 C Code 61

SAE flange no.	A	B	C	D	E ¹⁾	i	k	S ²⁾	max. pressure
	thread	[mm]	[mm]	[mm]	seal ring	[mm]	[mm]	thread	[bar]
10	G ½	46	54	36	18.66 – 3.53	38.1	17.5	M 8	345
11	G ¾	50	65	36	24.99 – 3.53	47.6	22.3	M 10	345
12	G 1	55	70	38	32.92 – 3.53	52.4	26.2	M 10	345
13	G 1-¼	68	79	41	37.69 – 3.53	58.7	30.2	M 10	276
14 ³⁾	G 1-½	82	98	50	47.22 – 3.53	79.9	35.7	M 12	345 ³⁾
30	G 1-½	78	93	45	47.22 – 3.53	79.9	35.7	M 12	207
15	G 2	90	102	45	56.74 – 3.53	77.8	42.9	M 12	207
16	G 2-½	105	114	50	69.44 – 3.53	88.9	50.8	M 12	172
17	G 3	124	134	50	85.32 – 3.53	106.4	61.9	M 16	138
18	G 4	146	162	48	110.72 – 3.53	130.2	77.8	M 16	34

Multi-flow Pumps, Pump Combinations, Sequence in order of type and size

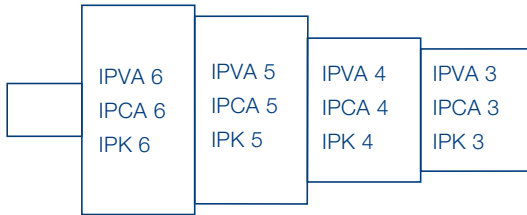

Pump Combinations

- IPVA, IPCA, IPK pumps of identical or different sizes can be combined in multiflow pumps.
- All sizes of the relevant pump volume are available as two- or three-flow pumps; four-flow pumps must be designed by Voith Turbo H + L Hydraulic.
- The pumps are arranged in increasing order according to frame size and delivery.

Selection

1. Determine pressure ranges and define the appropriate pump serie(s).
2. Determine pump volume and select the appropriate size
3. Define sequence of the pumps.
4. Check the torques.

Mounting, Assembly

- Multi-flow pumps are generally mounted to the drive by means of a flange.

Designs

Rotation and suction

clockwise (cw)



1



1

Special design

4

Mounting flange



0 SAE-2-hole-flange

7 SAE-2-hole-flange (variant)

Shaft end



1

Type Code

IPVA 3 - 3.5 1 0 1

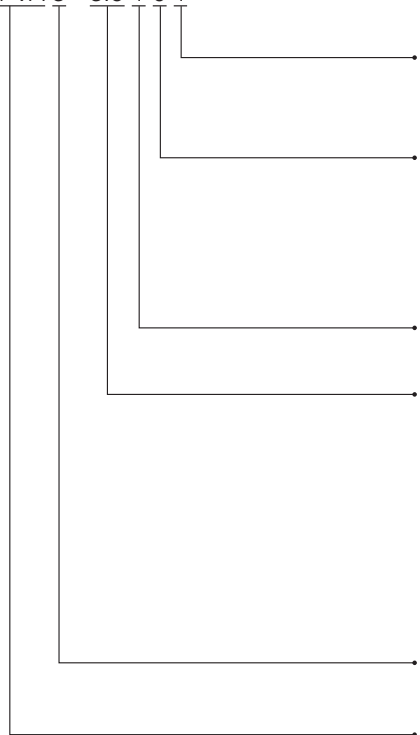

Shaft end

1 Parallel shaft with keyway

Mounting flange

0 SAE 2-hole
7 SAE 2-hole, variant

Rotation, suction port

1 Clockwise rotation, radial suction port radial

Delivery

Size	Delivery				
3	3.5	5	6.3	8	10
4	13	16	20	25	32
5	32	40	50	64	
6	64	80	100	125	

Size

Type

Type Code for Multiple Flow Capable Variants

IPVA 4/ - 20/ 1 7 1



following multiple flow capable pump stage of the same size, freely selectable delivery volumes

IPVA 4/3 - 20/ 1 7 1



following multiple flow capable predetermined pump stage of the same or smaller size, freely selectable delivery volumes

This is a translated document. Original language: german.
Legally binding language version of document: german.

Voith Turbo H+L Hydraulic GmbH & Co. KG
Schuckertstraße 15
71277 Rutesheim, Germany
Tel. +49 7152 992 3
Fax +49 7152 992 400
sales-rut@voith.com
www.voith.com/hydraulic-systems

